

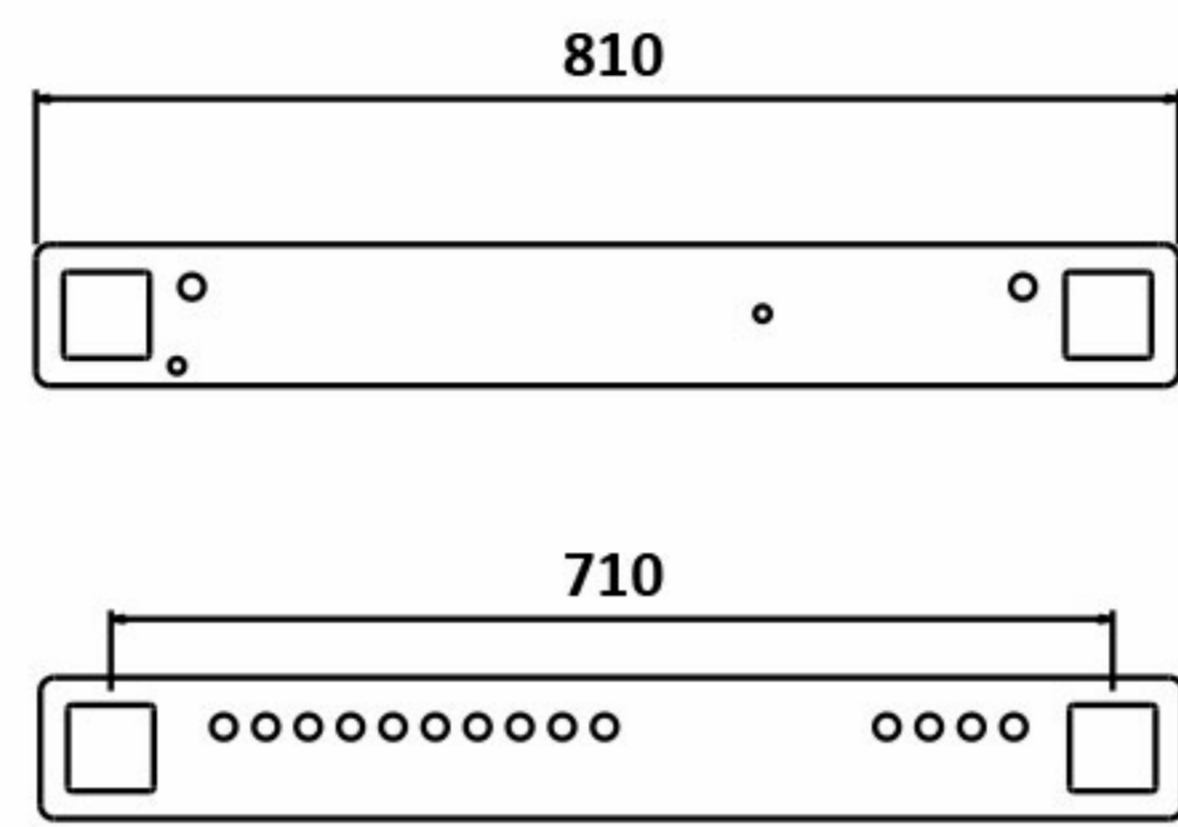

GT - GTA 1X12 L.A.

*Accessories
Accesorios*

An updated .pdf version of this manual is always available at www.prodgsystems.com

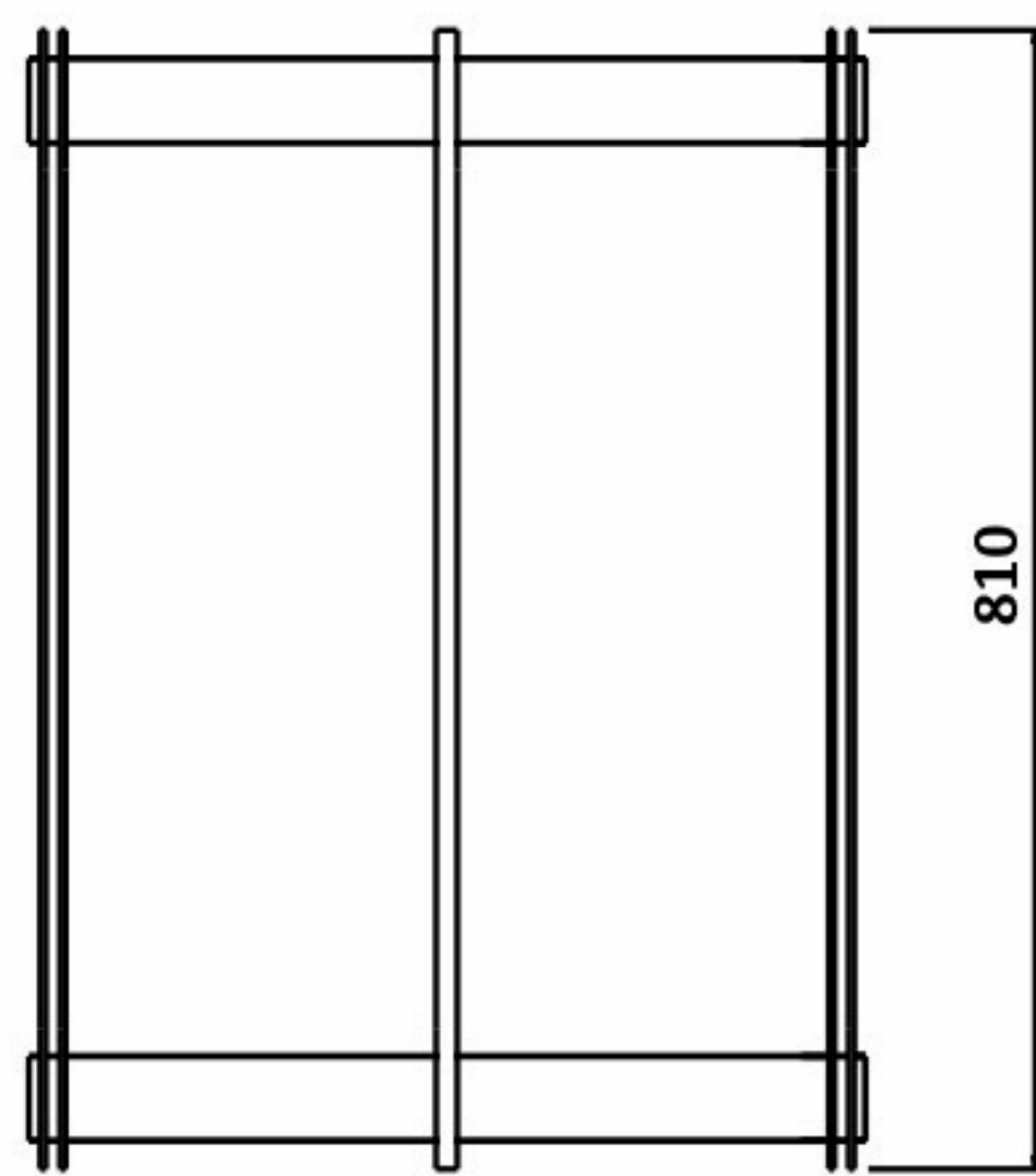

* Medidas expresadas en milímetros (mm)
* Expressed measures in millimeters (mm)

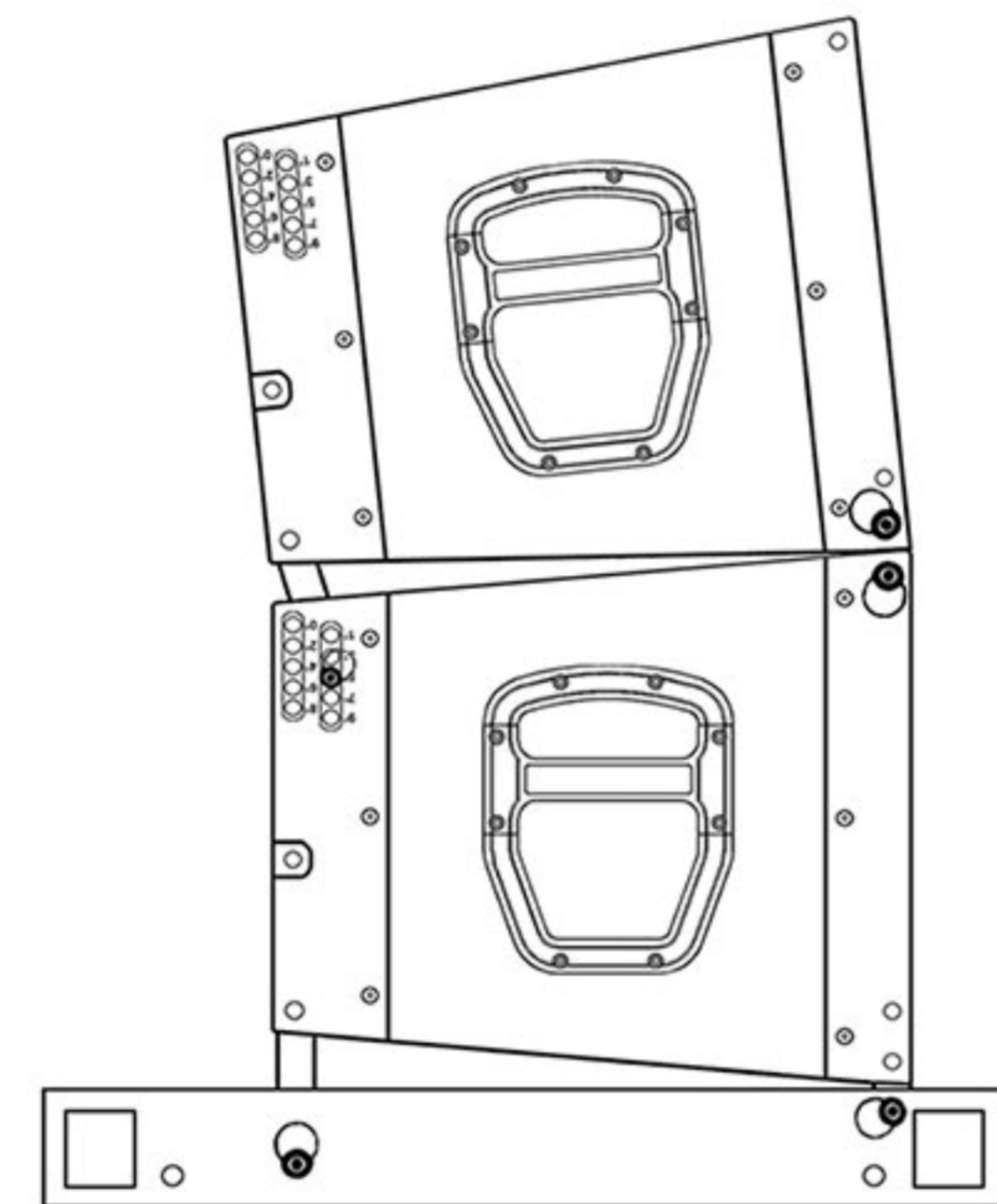
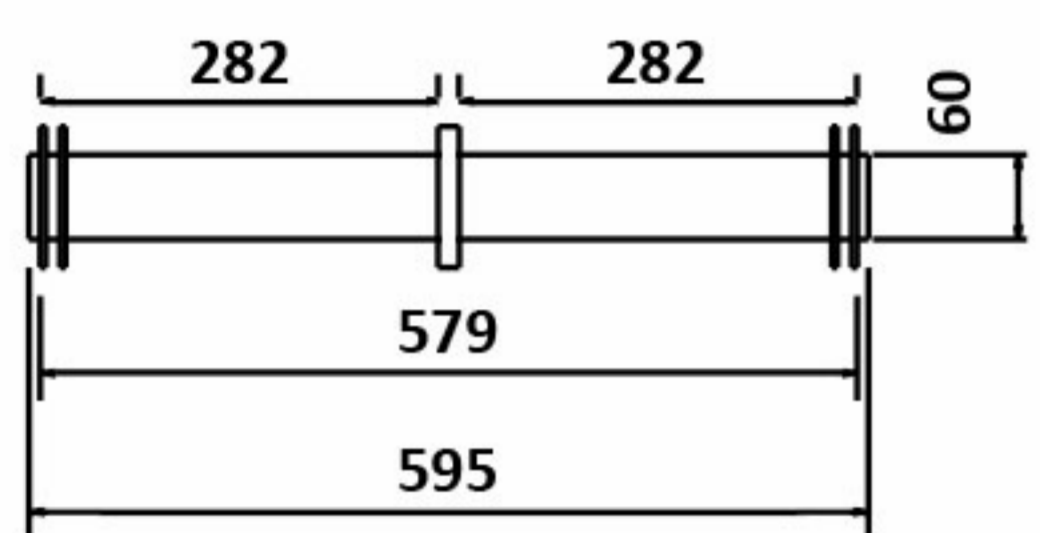

Bumper 12

Hardware de vuelo compuesto por un marco de acero ligero, cuatro pinlock y un grillete para elevar hasta 16 unidades **GT - GTA 1X12 L.A.** Permite utilizarse además como marco para “modo stack”.

Rigging hardware composed by a lightweight steel frame, four pinlock and a shackle to raise up until 16 units **GT - GTA 1X12 L.A.** It can be also used as frame for stack mode.

TR - 1X12

Patín de transporte para cuatro unidades **GT - GTA 1X12 L.A.** Incluye 4 ruedas giratorias de 100 mm con frenos de seguridad.

Dolly board to transport until four units **GT - GTA 1X12 L.A.** Includes four castor wheels of 100 mm with security brakes.

CV - 1X12

Funda de protección para 4 unidades **GT - GTA 1X12 L.A.** Especialmente dimensionada para el transporte utilizando el **TR - 1X12.**

Protection cover for 4 units **GT - GTA 1X12 L.A.** Particularly dimensioned for transport using **TR - 1X12.**

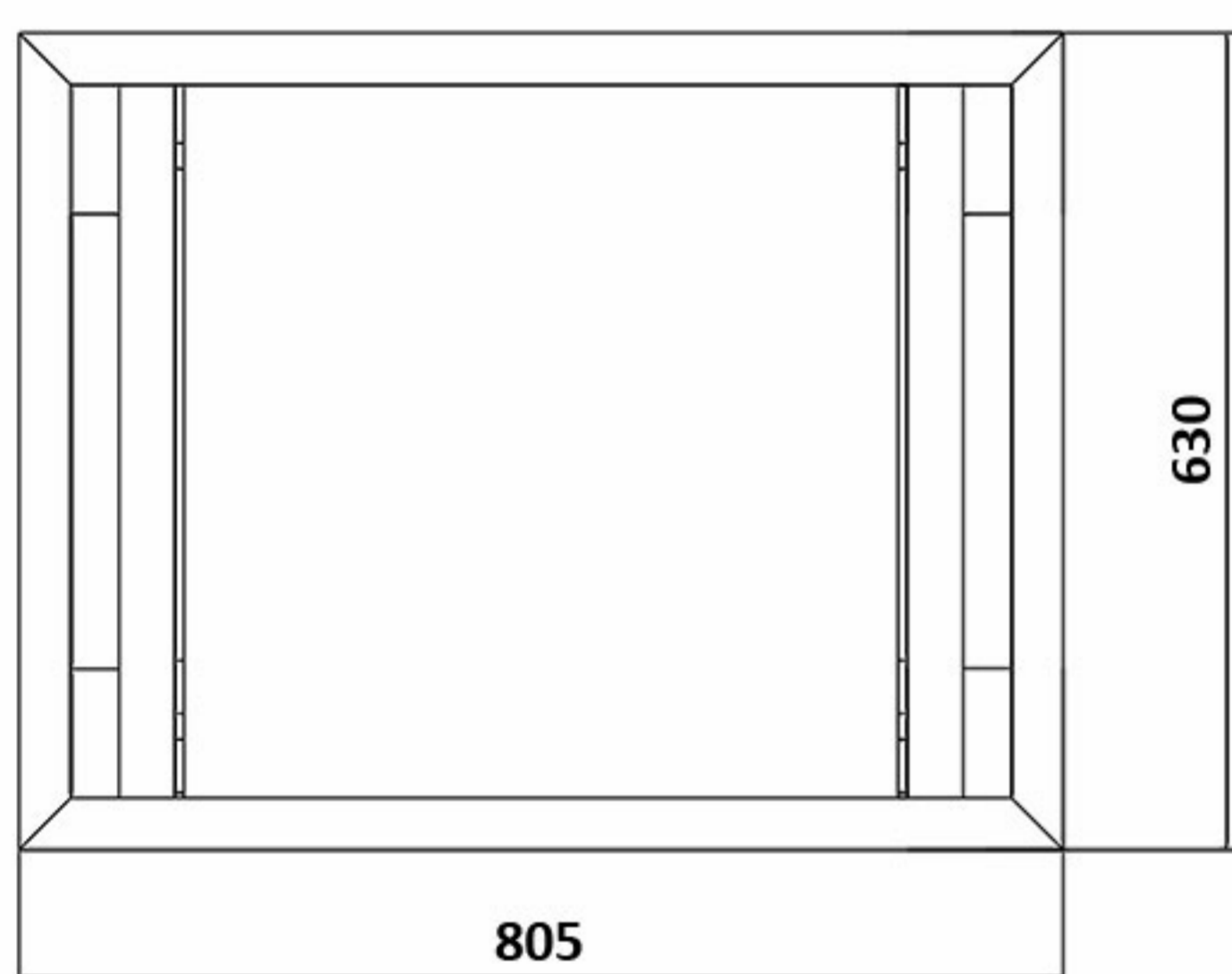
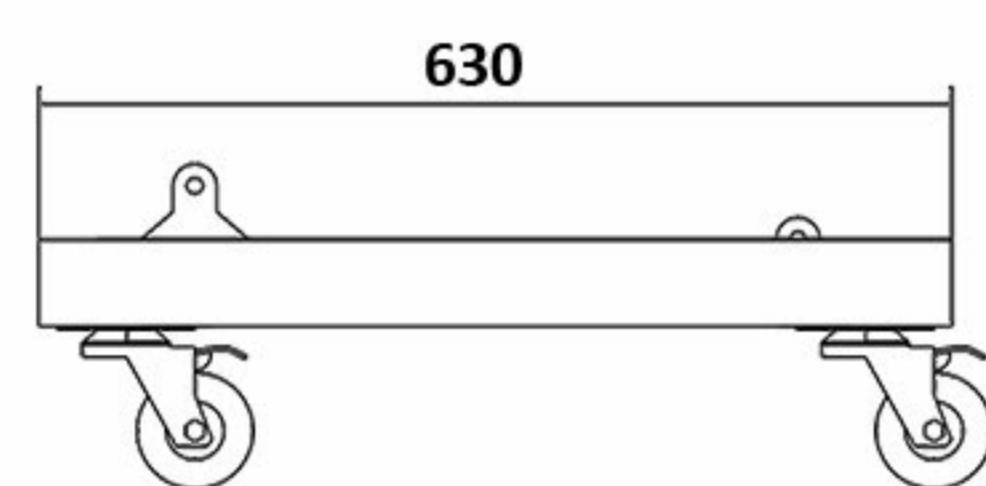
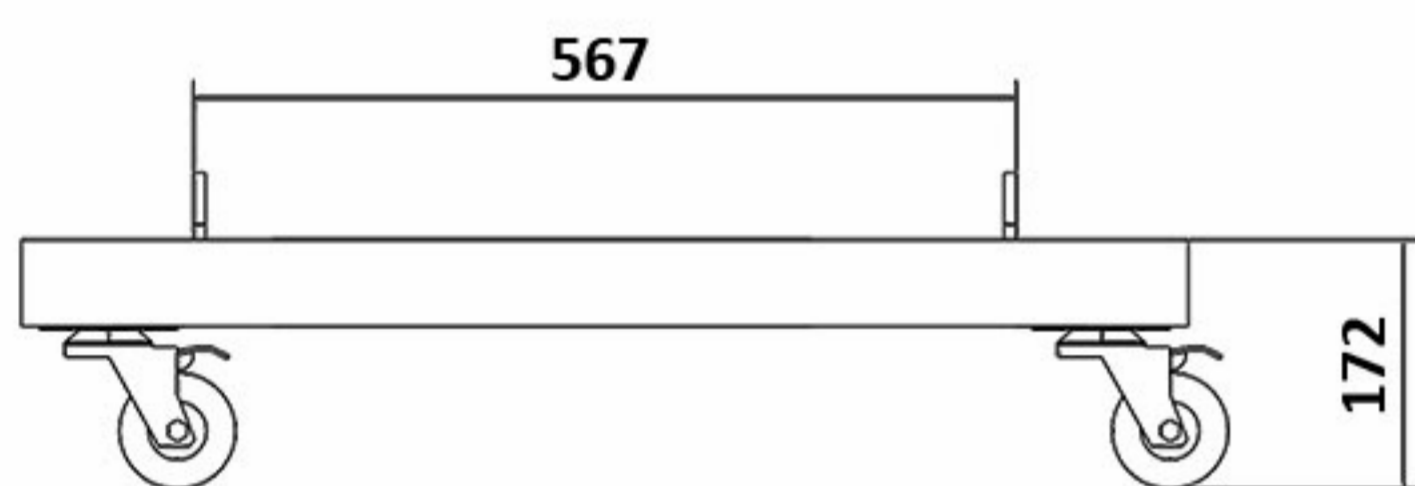

* Medidas expresadas en milímetros (mm)
* Expressed measures in millimeters (mm)

Medidas / Measures (HxWxD)
1510x595x460mm



* Medidas expresadas en milímetros (mm)
* Expressed measures in millimeters (mm)



Medidas / Measures (HxWxD)
1810x695x530mm

* Medidas expresadas en milímetros (mm)
* Expressed measures in millimeters (mm)

F / Case 1X12

Flight Case para transportar cuatro unidades **GT - GTA 1X12 L.A.** Incluye 4 ruedas giratorias de 100 mm con frenos de seguridad.

Flight Case to transport four units **GT - GTA 1X12 L.A.** Includes 4 castor wheels of 100 mm with security brakes.

www.prodgsystems.com

